



POWERING INNOVATION THAT DRIVES HUMAN ADVANCEMENT

© 2025 ANSYS, Inc. or its affiliated companies
Unauthorized use, distribution, or duplication is prohibited.

Getting Started with HFSS™: Ball Grid Array IC Package



ANSYS, Inc.
Southpointe
2600 Ansys Drive
Canonsburg, PA 15317
ansysinfo@ansys.com
<https://www.ansys.com>
(T) 724-746-3304
(F) 724-514-9494

Release 2025 R1
January 2025

ANSYS, Inc. and ANSYS
Europe, Ltd. are UL registered
ISO 9001:2015 companies.

Copyright and Trademark Information

© 1986-2025 ANSYS, Inc. Unauthorized use, distribution or duplication is prohibited.

ANSYS, Ansys Workbench, AUTODYN, CFX, FLUENT and any and all ANSYS, Inc. brand, product, service and feature names, logos and slogans are registered trademarks or trademarks of ANSYS, Inc. or its subsidiaries located in the United States or other countries. ICM CFD is a trademark used by ANSYS, Inc. under license. All other brand, product, service and feature names or trademarks are the property of their respective owners. FLEXIm and FLEXnet are trademarks of Flexera Software LLC.

Disclaimer Notice

THIS ANSYS SOFTWARE PRODUCT AND PROGRAM DOCUMENTATION INCLUDE TRADE SECRETS AND ARE CONFIDENTIAL AND PROPRIETARY PRODUCTS OF ANSYS, INC., ITS SUBSIDIARIES, OR LICENSORS. The software products and documentation are furnished by ANSYS, Inc., its subsidiaries, or affiliates under a software license agreement that contains provisions concerning non-disclosure, copying, length and nature of use, compliance with exporting laws, warranties, disclaimers, limitations of liability, and remedies, and other provisions. The software products and documentation may be used, disclosed, transferred, or copied only in accordance with the terms and conditions of that software license agreement.

ANSYS, Inc. and ANSYS Europe, Ltd. are UL registered ISO 9001: 2015 companies.

U.S. Government Rights

For U.S. Government users, except as specifically granted by the ANSYS, Inc. software license agreement, the use, duplication, or disclosure by the United States Government is subject to restrictions stated in the ANSYS, Inc. software license agreement and FAR 12.212 (for non-DOD licenses).

Third-Party Software

See the legal information in the product help files for the complete Legal Notice for Ansys proprietary software and third-party software. If you are unable to access the Legal Notice, please contact ANSYS, Inc.

Conventions Used in this Guide

Please take a moment to review how instructions and other useful information are presented in this documentation.

- Procedures are presented as numbered lists. A single bullet indicates that the procedure has only one step.
- Bold type is used for the following:
 - Keyboard entries that should be typed in their entirety exactly as shown. For example, “**copy file1**” means you must type the word **copy**, then type a space, and then type **file1**.
 - On-screen prompts and messages, names of options and text boxes, and menu commands. Menu commands are often separated by greater than signs (>). For example, “click **HFSS > Excitations > Assign > Wave Port.**”
 - Labeled keys on the computer keyboard. For example, “Press **Enter**” means to press the key labeled **Enter**.
- Italic type is used for the following:
 - Emphasis.
 - The titles of publications.
 - Keyboard entries when a name or a variable must be typed in place of the words in italics. For example, “**copy filename**” means you must type the word **copy**, then type a space, and then type the name of the file.
- The plus sign (+) is used between keyboard keys to indicate that you should press the keys at the same time. For example, “Press Shift+F1” means to press the **Shift** key and, while holding it down, press the **F1** key also. You should always depress the modifier key or keys first (for example, Shift, Ctrl, Alt, or Ctrl+Shift), continue to hold it/them down, and then press the last key in the instruction.

Accessing Commands: *Ribbons*, *menu bars*, and *shortcut menus* are three methods that can be used to see what commands are available in the application.

- The *Ribbon* occupies the rectangular area at the top of the application window and contains multiple tabs. Each tab has relevant commands that are organized, grouped, and labeled. An example of a typical user interaction is as follows:

"Click **Draw > Line**"



This instruction means that you should click the **Line** command on the **Draw** ribbon tab. An image of the command icon, or a partial view of the ribbon, is often included with the instruction.

- The *menu bar* (located above the ribbon) is a group of the main commands of an application arranged by category such File, Edit, View, Project, etc. An example of a typical user interaction is as follows:

"On the **File** menu, click the **Open Examples** command" means you can click the **File** menu and then click **Open Examples** to launch the dialog box.

- Another alternative is to use the *shortcut menu* that appears when you click the right-mouse button. An example of a typical user interaction is as follows:

"Right-click and select **Assign Excitation > Wave Port**" means when you click the right-mouse button with an object face selected, you can execute the excitation commands from the shortcut menu (and the corresponding sub-menus).

Getting Help: Ansys Technical Support

For information about Ansys Technical Support, go to the Ansys corporate Support website, <http://www.ansys.com/Support>. You can also contact your Ansys account manager in order to obtain this information.

All Ansys software files are ASCII text and can be sent conveniently by e-mail. When reporting difficulties, it is extremely helpful to include very specific information about what steps were taken or what stages the simulation reached, including software files as applicable. This allows more rapid and effective debugging.

Help Menu

To access help from the Help menu, click **Help** and select from the menu:

- **[product name] Help** - opens the contents of the help. This help includes the help for the product and its *Getting Started Guides*.
- **[product name] Scripting Help** - opens the contents of the *Scripting Guide*.
- **[product name] Getting Started Guides** - opens a topic that contains links to Getting Started Guides in the help system.

Context-Sensitive Help

To access help from the user interface, press **F1**. The help specific to the active product (design type) opens.

You can press **F1** while the cursor is pointing at a menu command or while a particular dialog box or dialog box tab is open. In this case, the help page associated with the command or open dialog box is displayed automatically.

Table of Contents

Table of Contents	Contents-1
1 - Introduction	1-1
2 - Set Up the Model	2-1
Open the Model	2-1
Verify Solution Type	2-1
Review Boundaries	2-2
RadiationBoundary	2-3
ReferencePlanes Boundary:	2-3
Available Boundary Conditions	2-4
Assign Excitations	2-5
3 - Analyze the Model	3-1
Create Face List for Field Saving	3-1
Add Solution Setup	3-2
Settings in the Solution Setup	3-6
Set Up HPC Options and Run Simulation	3-7
4 - Generate Reports	4-1
Input Pulse and Response	4-1
Residual	4-3
E-Fields Overlay	4-5
S-Parameters vs. Frequency	4-10

1 - Introduction

In this project, you will perform a transient analysis of a Ball Grid Array (BGA) IC package. You will visualize the propagation of a short pulse by creating a transient plot of $Y1$ vs. Time, create a transient plot of the residual, obtain S-parameters over a broad frequency range, and view an overlay of the transient E-fields.

The geometry corresponds to a portion of a BGA-type chip package. The model has four signal lines as well as power and ground nets.

Network Analysis

You can perform a network analysis in both the frequency domain and the time domain (transient analysis). In addition to obtaining the familiar S-parameters, you can perform the analysis in the time domain to visualize the propagation of a short pulse through a device. You will do so in this exercise.

Sample Project: BGA IC Package

The model is installed with the Ansys Electronics Desktop application, and it is located in a sub-folder within the Help branch of the installation path.

The geometry is complete – no additions or modifications are needed. However, you will apply the excitations, set up and run the analysis, and generate the reports and field overlay.

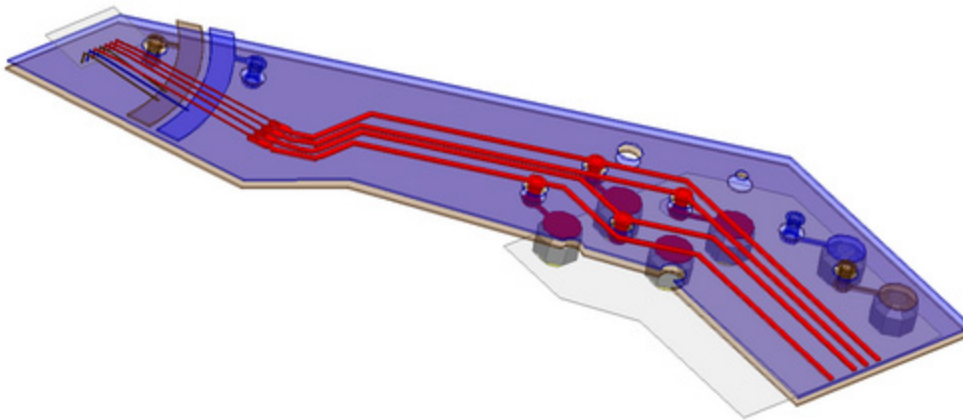

Figure 1-1: BGA IC Package Geometry



2 - Set Up the Model

This chapter contains the following topics:

- Open the Model
- Verify Solution Type
- Review Boundaries
- Assign Excitations

Open the Model

Begin with Ansys Electronics Desktop launched but no project open.

1. On the **Desktop** ribbon tab, click  **Open Examples**. Then:
 - a. In the *Open* dialog box that appears, click the parent folder icon () once to move up one level above the *Examples* folder.
 - b. Double-click the **Help** folder and then the **HFSS** folder.
 - c. Select the file **Alinks_BGA.aedt** and click **Open**.

Note:

The project is deliberately incomplete. You need to add excitations and a solution setup to analyze the model and perform post processing. For this reason, the project file is located in the *Help* folder instead of the *Examples* folder.

2. On the **Desktop** ribbon tab, click  **Save As**.
3. Navigate to a working folder of your choice (you can't write to the program installation path) and click **Save** to place a copy of the model in your working folder using the same file name.

Verify Solution Type

1. Under *Alinks_BGA* in the Project Manager, right-click **HFSSModel1 (Transient Network)** and choose **Solution Type** from the short-cut menu.

The *Solution Type* dialog box appears.

2. Ensure that the settings are as shown in the following figure and then click **OK**:

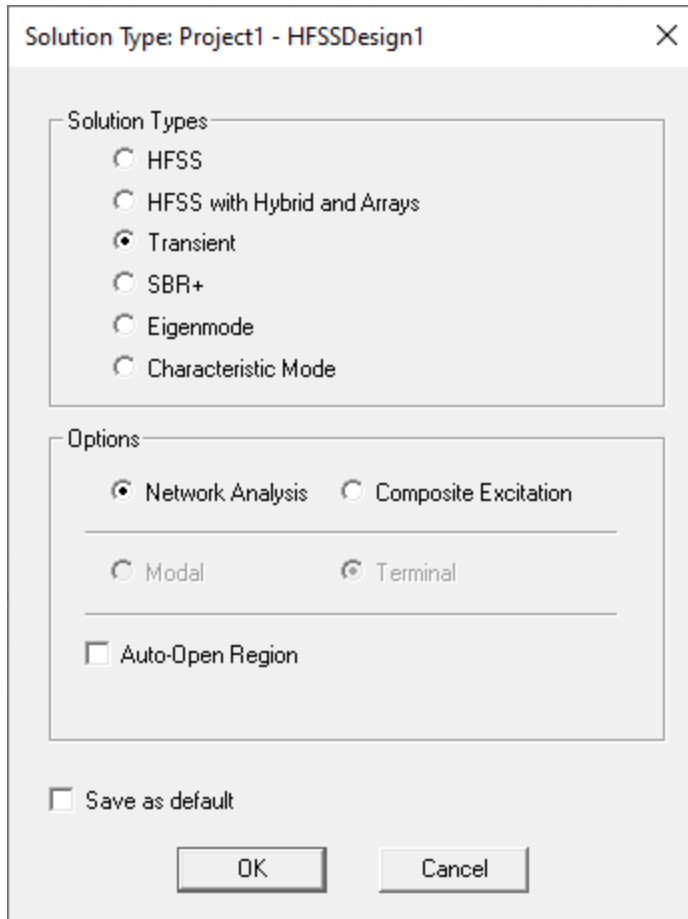

Figure 2-1: Solution Type

Review Boundaries

Two boundary conditions have already been defined:

1. Select each item under *Boundaries* in the Project Manager to see where the boundary conditions are assigned.



Figure 2-2: Boundaries

RadiationBoundary

The radiation boundary is applied to all outer faces of an air volume that surrounds the model. Fields are calculated inside the air volume, which is large enough for an accurate signal-integrity simulation. You will not determine the radiated fields for this exercise.

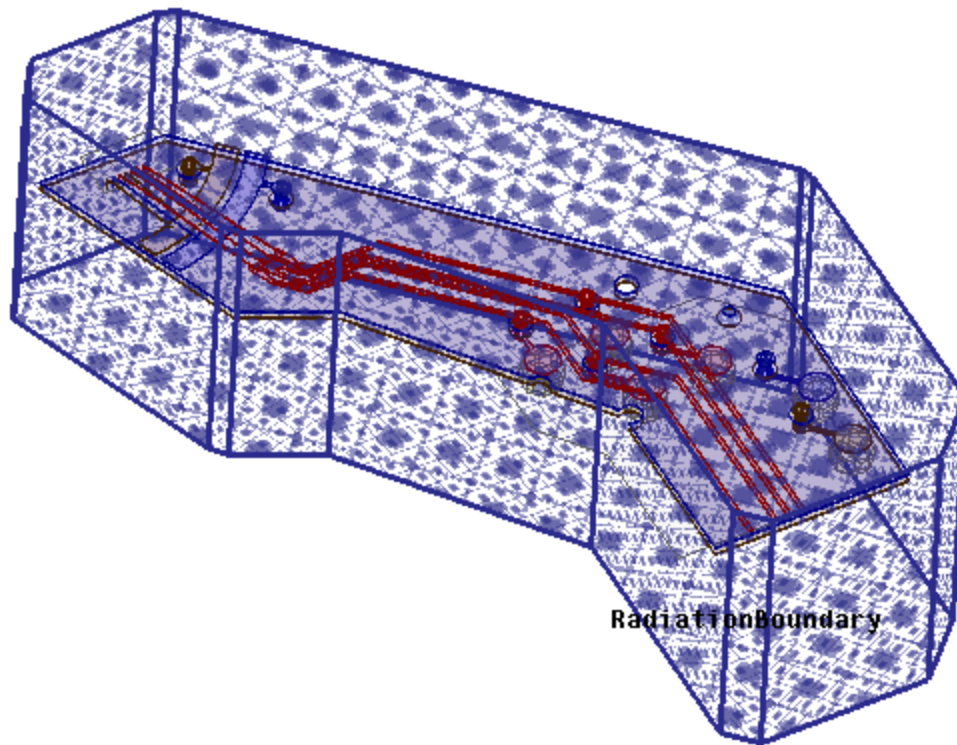

Figure 2-3: *RadiationBoundary*

***ReferencePlanes* Boundary:**

The *ReferencePlanes* boundary is a Perfect E boundary applied to two faces of the BGA model. These planes provide references ("ground") to the ports. Since the power and ground nets are also connected to these planes, each signal current has a return path. This configuration is necessary for a meaningful simulation.

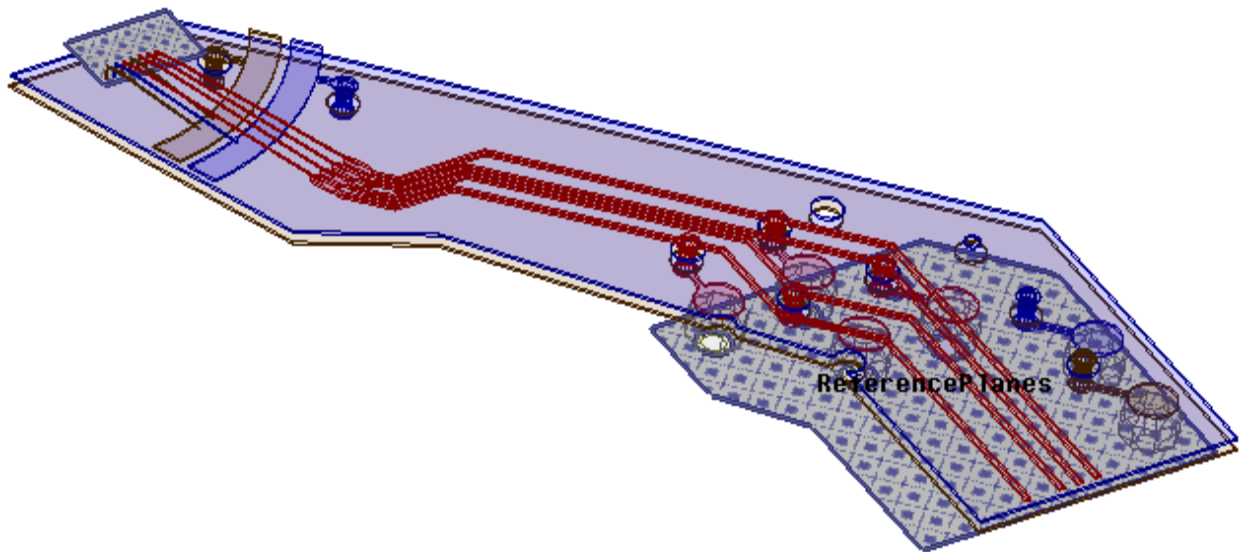

Figure 2-4: *ReferencePlanes* Boundary

Available Boundary Conditions

Take a few moments to see what other boundary conditions are available in *HFSS Transient* analyses:

2. Right-click in the Modeler window and point to **Assign Boundary**, but do not make a selection.

Boundaries that are unavailable (grayed out) are sometimes frequency-dependent (such as *Coupled > Primary* and *Secondary*) and are not straightforward to implement in the time domain.

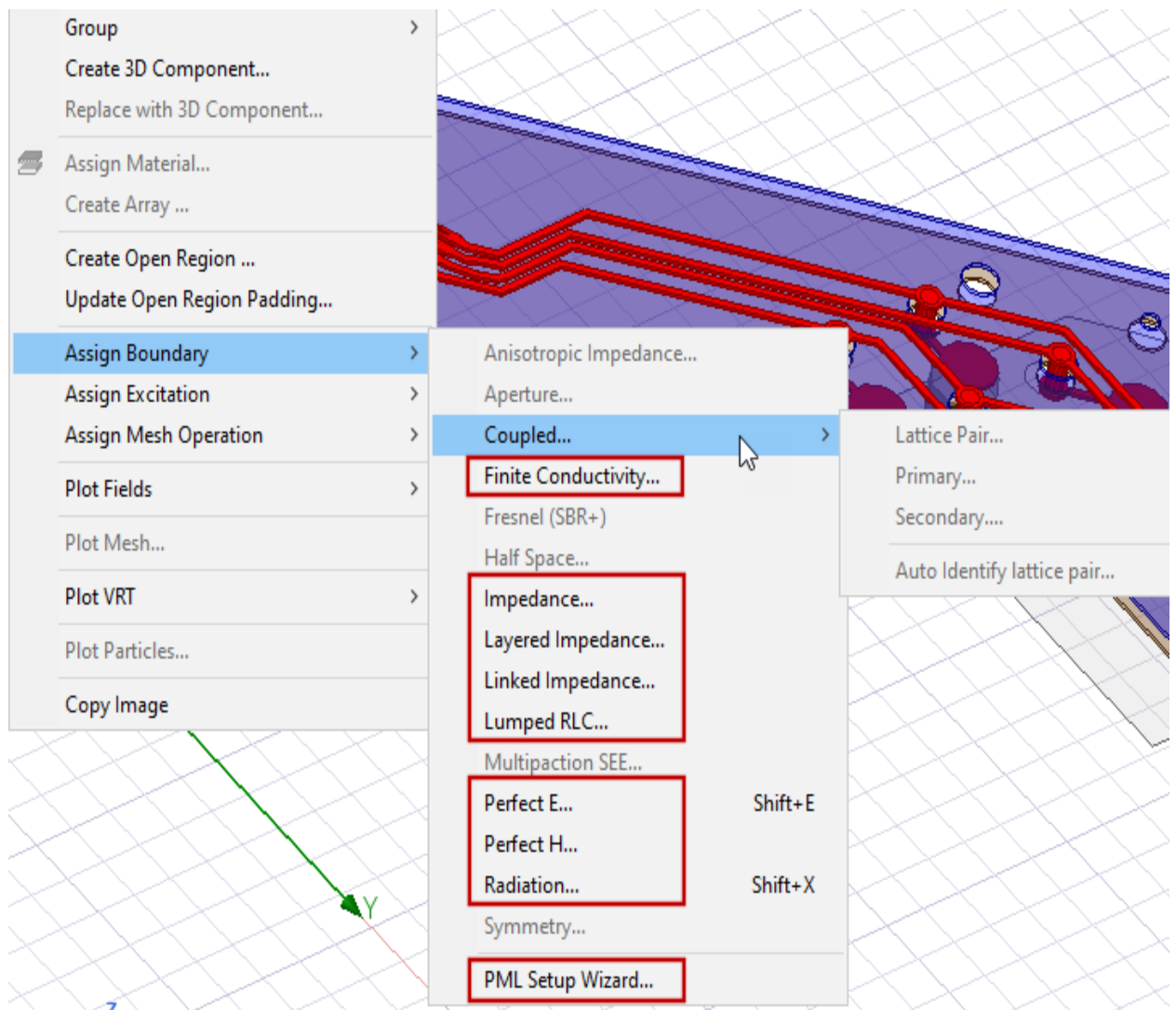

Figure 2-5: Boundaries shortcut menu

3. Click in the Modeler window background area to cancel and close the shortcut menu.

Assign Excitations

In this section you will assign excitations to all the sheet objects that appear under **Unassigned** in the History Tree.

1. In the History Tree, expand **Model**, **Sheets**, and **Unassigned**.
2. Right-click the first unassigned sheet object **LNK_12_BW** and choose **Assign Excitation > Port > Terminal Lumped Port** from the short-cut menu.

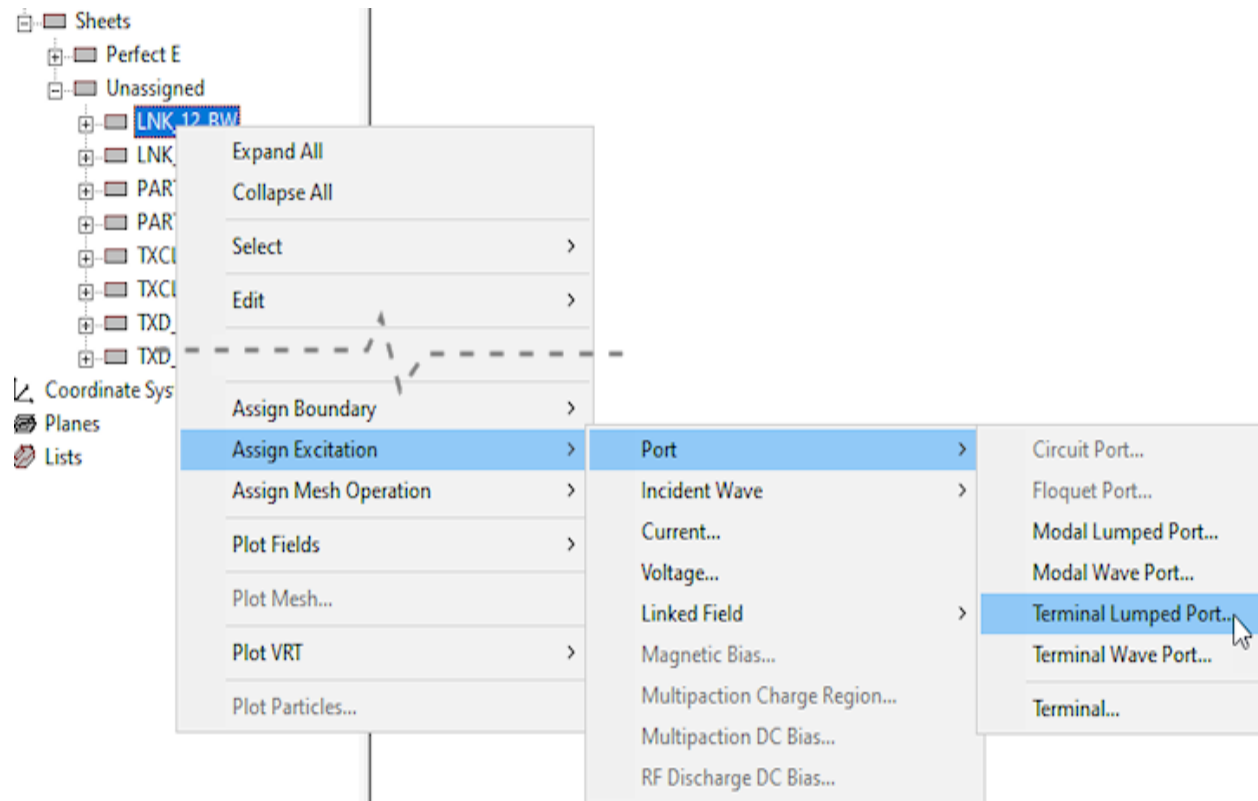

Figure 2-6: Assign Lumped Port Excitation

The *Reference Conductors for Terminals* dialog box appears.

3. For the *Conductor* **BONDWIRE_REFPLANE_1**, select the **Use as Reference** option. Keep the default *Port Name*, ensure that all other settings are as shown in the following figure.

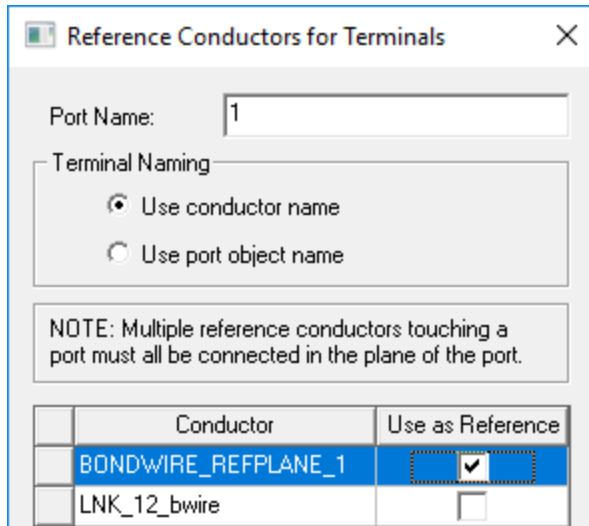

Figure 2-7: Reference Conductors for Terminals (Port 1)

4. Click **OK**.

LNK_12_BW moves from the *Model > Sheets > Unassigned* branch of the History Tree to a new *Lumped Port* branch. Therefore, the first item now listed under *Unassigned* is the one to which you will assign the second lumped port.

5. Similarly, select the remaining objects under **Unassigned** in the History Tree one by one and assign a terminal lumped port to each of them.

Note:

For every object, the conductor that has the reference plane 1 boundary associated with it (...*REFPLANE_1*) should be set to **Use as Reference**. The **Highlight selected conductors** option at the bottom of the dialog box is selected by default.

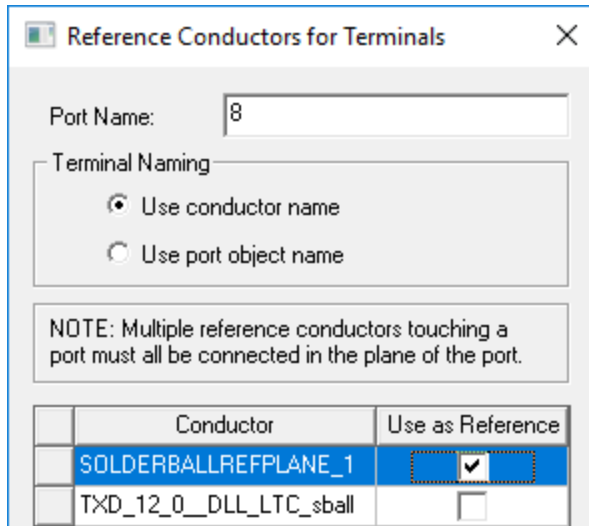

Figure 2-8: Reference Conductors for Terminals (Port 8)

6. One by one, select each port (1 through 8) listed under *Excitations* in the Project Manager and do the following in the docked *Properties* window:
 - Deselect the **Renorm All Terminals** option:

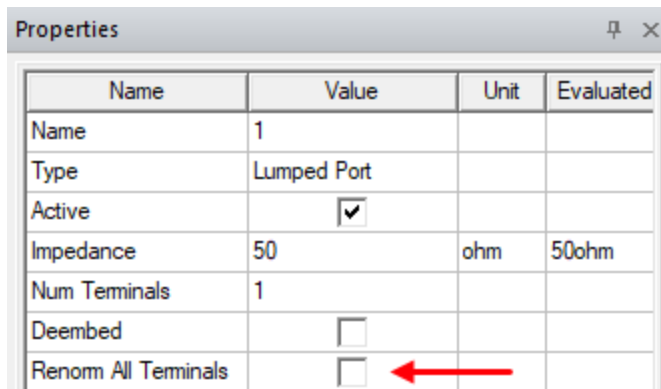

Figure 2-9: Lumped Port Properties (Port 1)

This action prevents port renormalization when post processing.

7. Right-click **Excitation** in the Project Manager and select **Auto-Assign Terminals** from the short-cut menu.

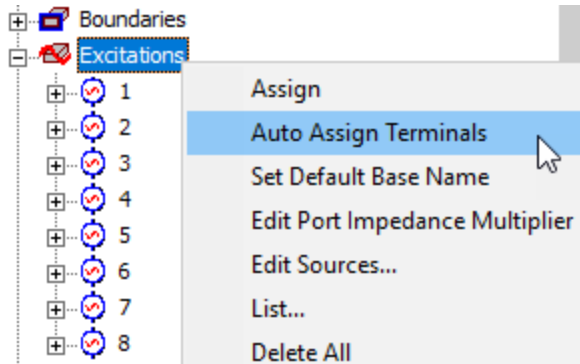

Figure 2-10: Selecting *Auto Assign Terminals*

The *Reference Conductors for Terminals* dialog box appears.

8. Edit the settings as shown in following figure and then click **OK**.

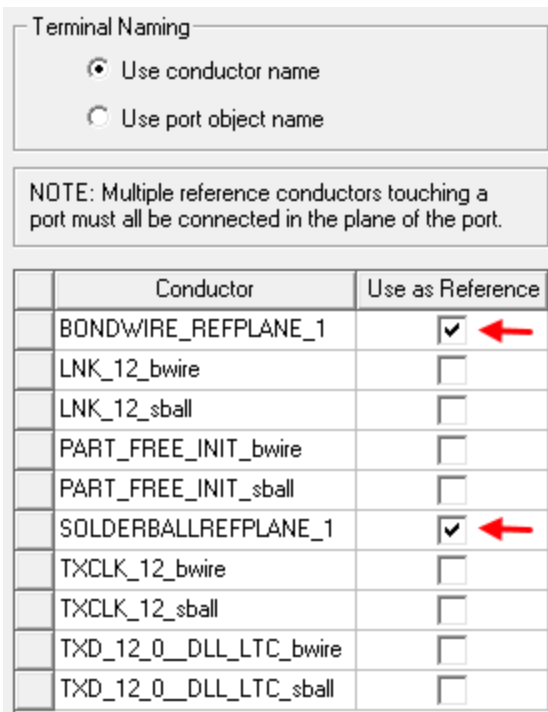
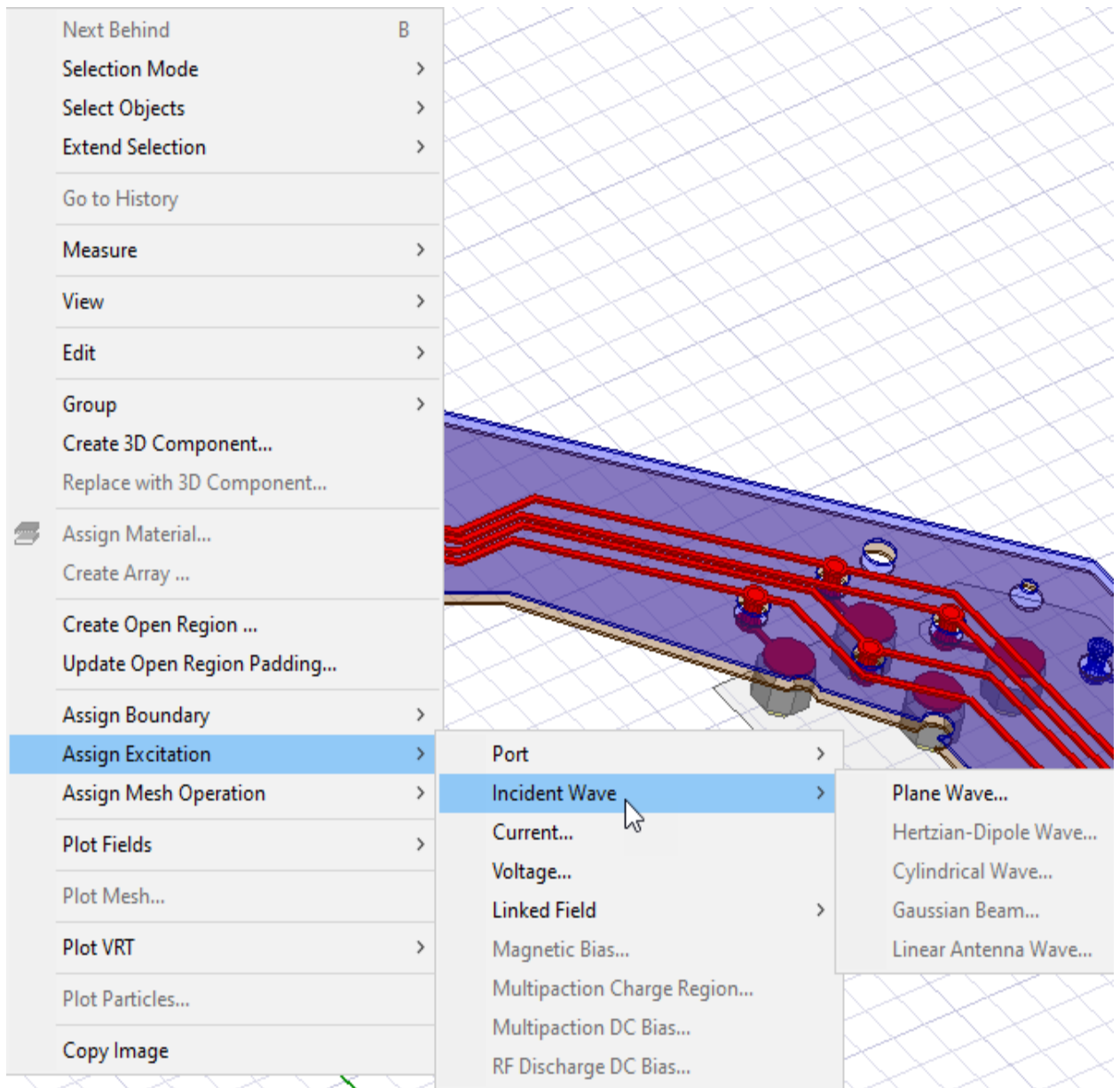

Figure 2-11: Reference Conductors for Terminals (All Ports)

Take a few moments to see what other excitations are available in *HFSS Transient* analyses.

9. Right-click in the Modeler window and point to **Assign Excitation** in the shortcut menu.

The list of available excitations appears. The items in gray text are unavailable:



We are not targeting certain applications: Unit cells of periodic structures (phased arrays, FSS) or models with magnetic bias (ferrite circulators, ferrite phase shifters). HFSS handles these applications better in the frequency domain.

Note:

You can see that only the *Plane Wave* excitation is available under *Incident Wave*. If you expand the *Linked Field* branch, you will see that none of these excitations are currently available.

10. Click in the background to cancel the shortcut menu.

3 - Analyze the Model

This chapter contains the following topics:

- Create Face List for Field Saving
- Settings in the Solution Setup
- Run Simulation
- Generate Reports
- Matrix Post Processing
- Fields Post Processing
- How to Set up HPC Integration

Create Face List for Field Saving

First define a face list that includes the faces where fields are to be saved. To make selection of the appropriate faces easier, you can hide the *air_box* and *DIELECTRIC* objects.

1. Under *Model > Solids > air* in the History Tree, select **air_box**.
2. Hold down the **Ctrl** key and, under *Model > Solids > FR4_epoxy_lossless* in the History Tree, also select **DIELECTRIC**.
3. On the **Draw** ribbon tab, click  **Hide selected objects in active view**.

The two objects are hidden, and they can remain hidden throughout the remainder of this getting started exercise.

4. Press the **F** hotkey to begin the *face-selection* mode.
5. Select the top surfaces of both the power and the ground plane, as shown in the following figure. (Rotate the model view and zoom in as needed for a clear view of the two faces.)

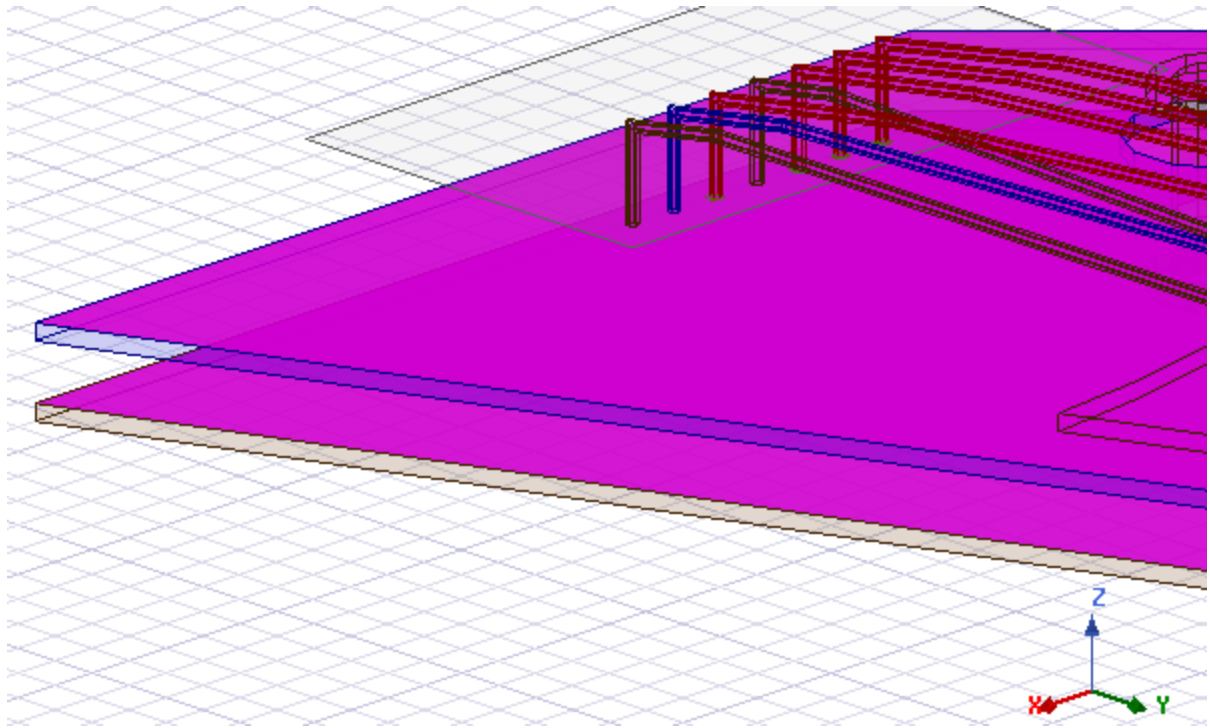



Figure 3-1: Power and Ground Planes Selected

6. Using the menu bar, click **Modeler > List > Create > Face List**.
7. Under *Lists* in the History Tree, select **FaceList1**.

The list settings appear in the docked *Properties* window.

8. Change the **Name** from *Facelist1* to **PlotFields** and press **Enter**.
9. If you zoomed in when selecting the faces, and part of the model extends beyond the limits of the display area, do the following:

On the **Draw** ribbon tab, click  **Fit All** (or press **Ctrl+D**) to fit the model to the display area.

Add Solution Setup

1. On the **Simulation** ribbon tab, click  **Setup** (*Add solution setup*).
2. In the **General** tab of the *Transient Solution Setup* dialog box that appears, ensure that the settings are as shown in following figure:

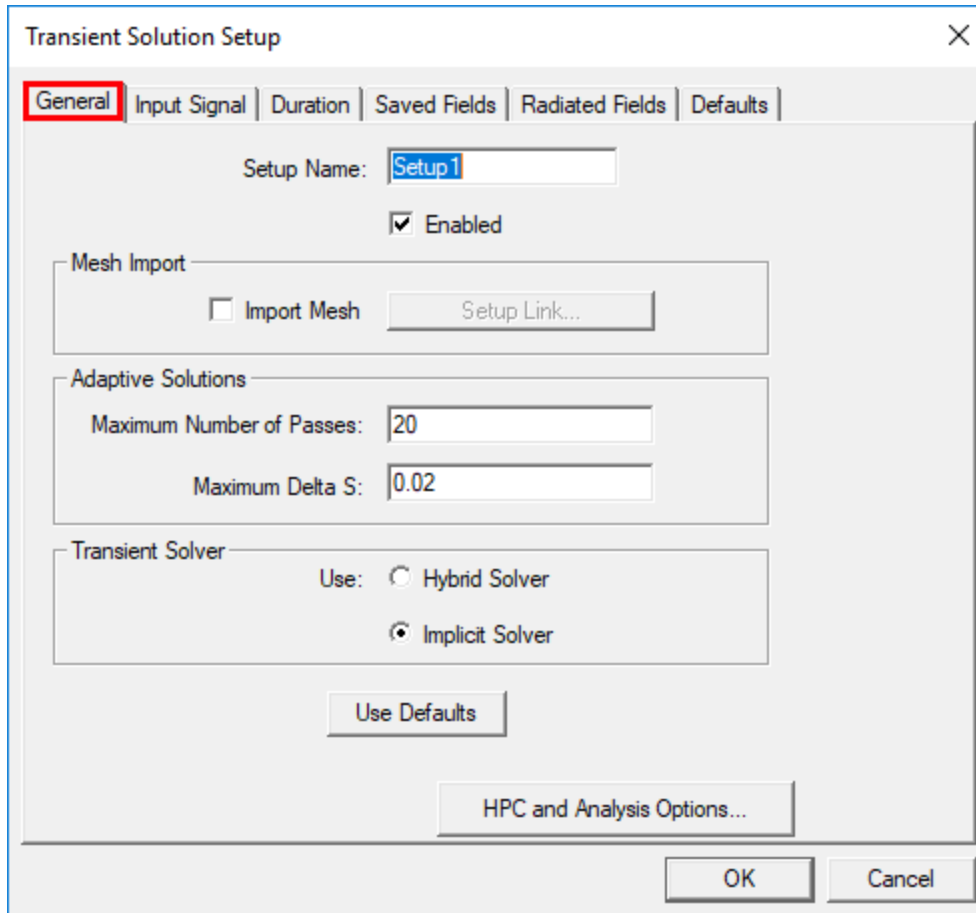

Figure 3-2: Transient Solution Setup – General Settings

Note:

HFSS Transient automatically sets parameters for determining the mesh, such as the use of mixed element orders and the iterative solver in the frequency domain. The frequency at which the mesh is automatically adapted is based on the time profile you specify next.

3. Select the **Input Signal** tab and edit the settings as shown in the following figure:

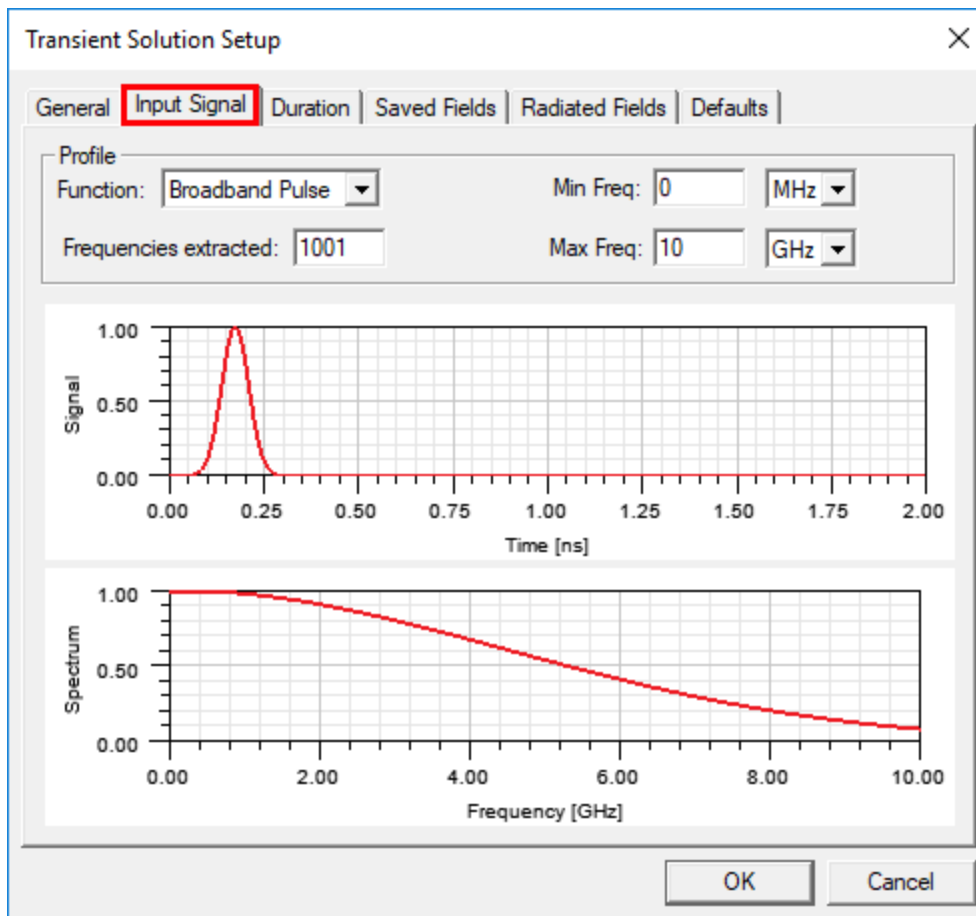

Figure 3-3: Input Signal Settings

The result will resemble that of an interpolating frequency sweep with the same specifications.

Note:

For more information, see [Settings in the Solution Setup](#).

4. Select the **Duration** tab and specify the settings shown in the following figure:

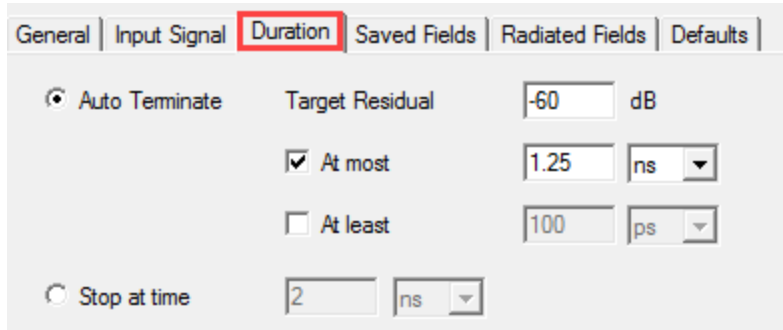

Figure 3-4: Duration Settings

Note:

The simulation will run until transient fields have mostly died out, determined by the **Target Residual**. Additionally, a maximum simulated time is determined by the equation:

$$20 \times (\text{model size}) / (\text{speed of light}).$$

In this case, you are setting an extra limitation on the duration. Considering the length of the traces, in one nanosecond, the signal can travel from source to termination and back several times. It is therefore reasonable to limit the simulated time to at most 1.25 ns, being the aforementioned 1 ns plus the duration of the input signal.

5. Select the **Saved Fields** tab, specify the settings shown in the following figure, and then click **OK**.

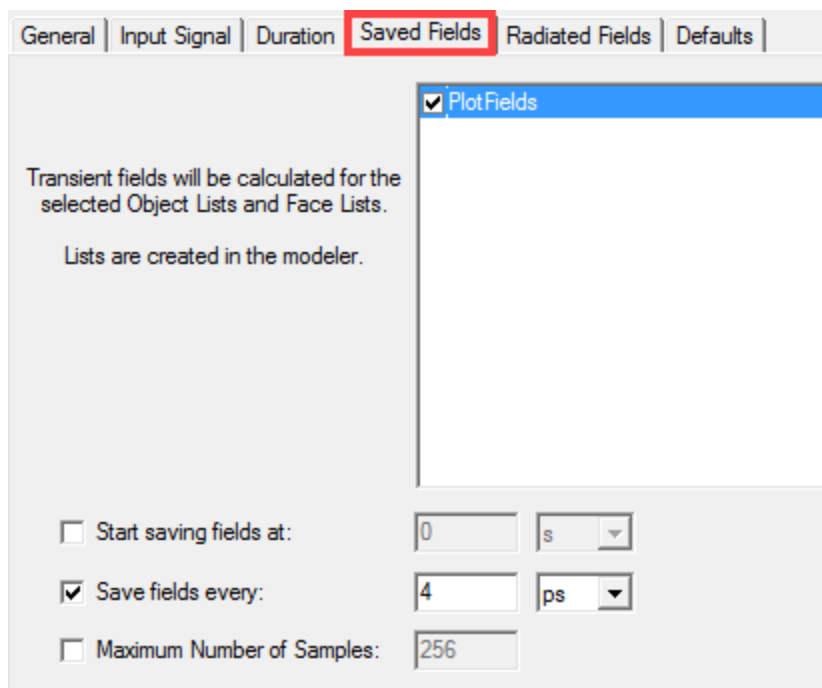
**Figure 3-5: Save Fields Settings****Note:**

4 ps is somewhat arbitrary. In 4 ps, the signal travels 0.6 mm in dielectric, so this sampling rate should provide a smooth animation for this model.

Settings in the Solution Setup

You can create a time-domain profile by specifying minimum and maximum frequencies. If you specify zero for the lower bound, the pulse shape changes and will really include frequencies all the way down to DC. In addition to the sweep, a TDR pulse can be defined. This pulse is the same as the sweep from DC to a certain maximum frequency, but, for your convenience, it is specified by rise time.

Finally, note that you must specify the profile only once for all active excitations. In the more general Transient (“non Network Analysis”) design, you can specify different time profiles for different excitations and run one simulation with all active excitations turned on simultaneously. In Transient Network Analysis, all active excitations get the same time profile one by one, and you get one simulation per active excitation. This method is the proper way to characterize a network.

Set Up HPC Options and Run Simulation

The simulation will take about 400 MB of memory per excitation. If you have all ports active we recommend you distribute the simulation if possible. In a distributed simulation, with at least eight processors and with enough RAM, each one of the eight excitations gets its own process, and they will all solve simultaneously.

Assuming your workstation has at least eight processing cores, you will set up the high-performance computing (HPC) options to take advantage of them.

1. On the **Simulation** ribbon tab, click  **HPC Options**.

The *HPC and Analysis Options* dialog box appears.

2. Ensure that **HFSS** is selected in the **Design Type** drop-down menu and then click **Add**.

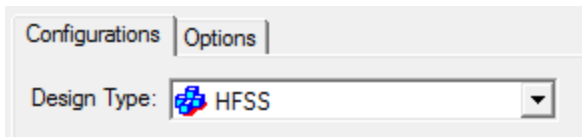

Figure 3-6: Design Type for HPC Setup

The *Analysis Configuration* dialog box appears.

3. In the **Configuration Name** text box, type **Eight Cores**.
4. Ensure that the following two options are selected and then click **Add Machine to List**:
 - **Use Automatic Settings**
 - **Local Machine** (under *Machine Details*)

The *localhost* entry is added to the *Machines for Distributed Analysis* list.

5. Set the *localhost* values for **Cores** and **RAM Limit (%)** as shown in the following figure. The red numbers correspond to the step numbers in this procedure.

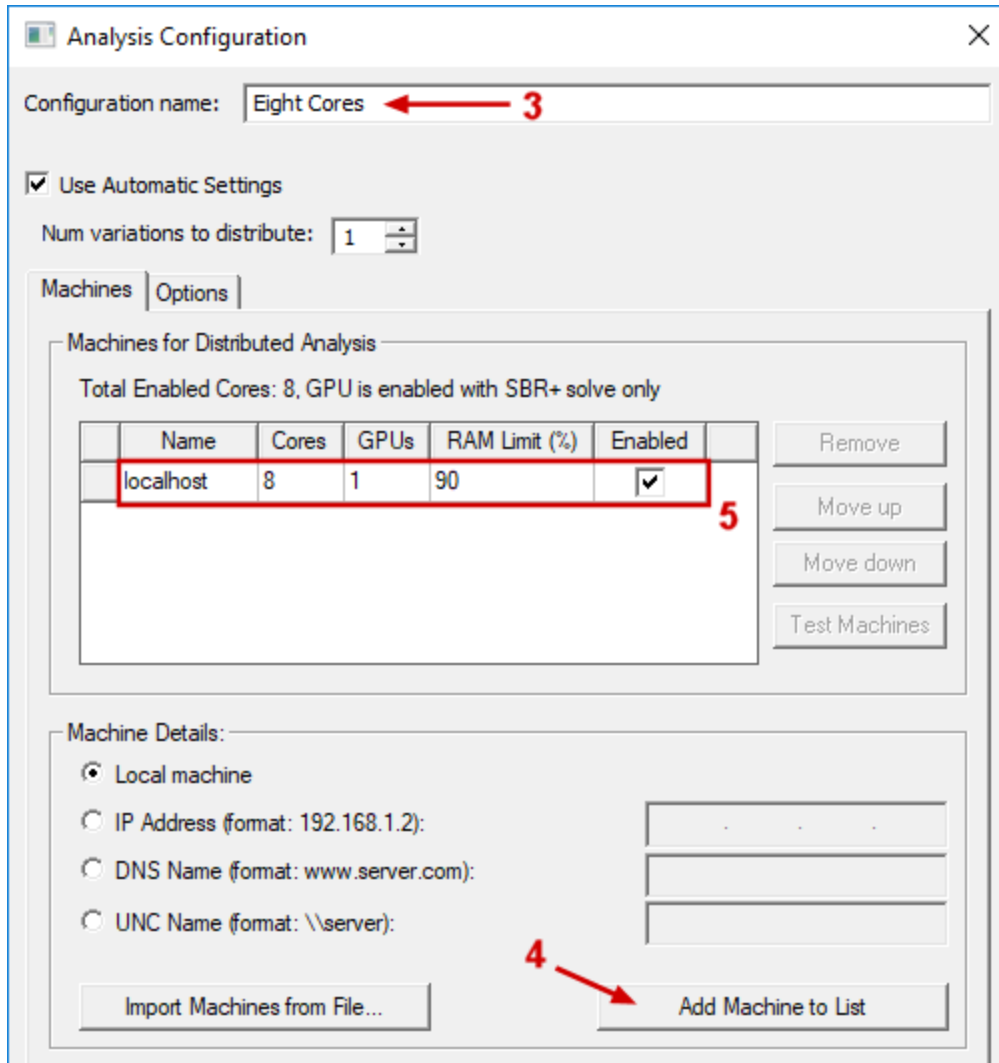
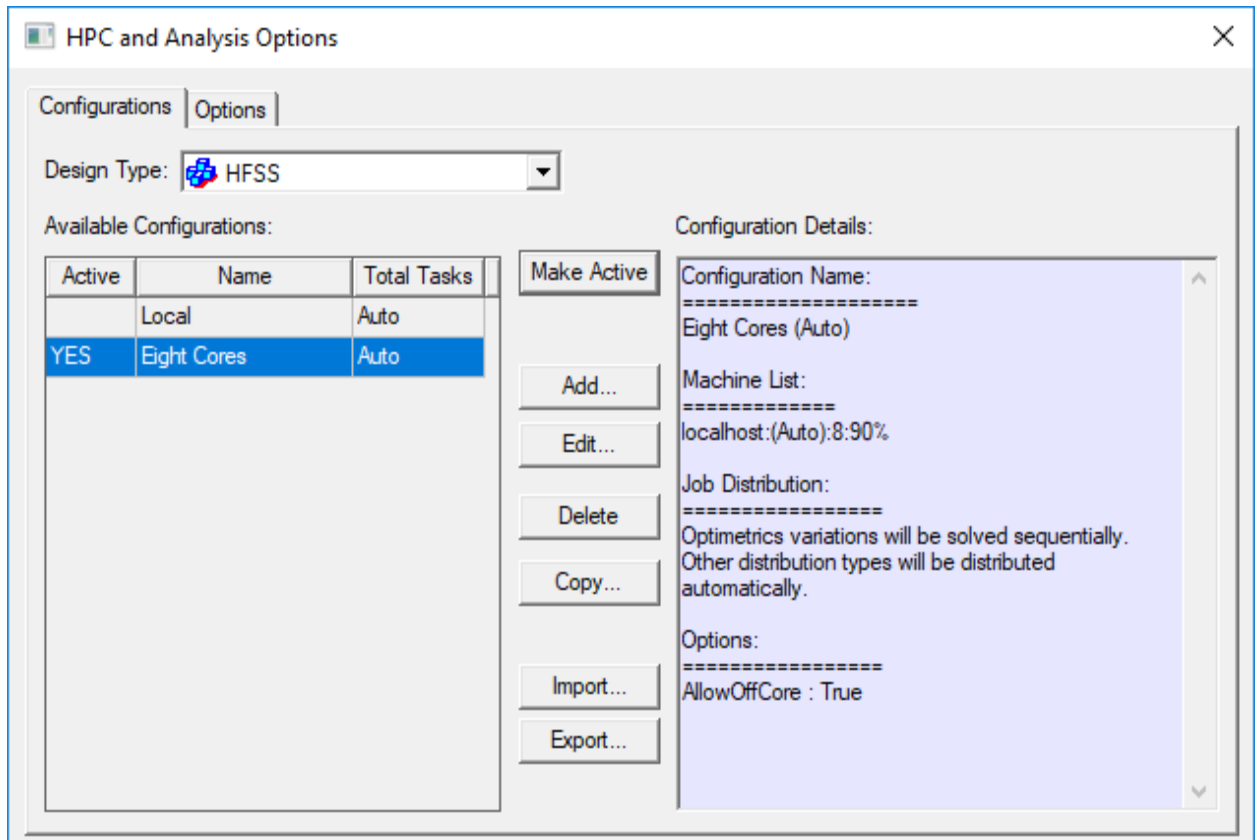



Figure 3-7: HPC Analysis Configuration for localhost

6. Click **OK**.
7. With the **Eight Cores** configuration selected, click **Make Active**.

The *HPC and Analysis Options* dialog box should now match the following figure:



8. Click **OK** to accept the configuration and close the dialog box.
9.  **Save** the project. (This command is available from all ribbon tabs).
10. On the **Simulation** ribbon tab, click  **Analyze All**.

HFSS first performs the frequency-domain adaptive passes, after which it completes the eight transient simulations, one per excitation.

4 - Generate Reports

You can generate reports while the simulation is running, though the completed traces won't plot until the solution is finished. Data is plotted as it becomes available from the solver.

You can keep track of input signals, outputs on the various ports, and field residuals as the simulation is progressing. You can generate both time-domain (transient) and frequency-domain plots.

In this section, you will create three transient plots (results versus time) and one plot of results versus frequency, as follows:

- **Input Pulse and Response:** Transient plot of input pulse at port 1 and output response at ports 5 and 6
- **Residual:** Transient plot of residual at port 6
- **E-Fields Overlay:** Transient E-field overlay displayed on two previously designated model faces (power and ground plane)
- **S-Parameters vs. Frequency:** Specifically, S(6,5) and S(6,6)

In each case, you will select the appropriate terminal names in the *Report* dialog box when defining the plots (and not the simple lumped port excitation numbers shown in the preceding bullet list).

Input Pulse and Response

The first of three transient plots you will create consists of the following three traces vs. Time (in nanoseconds):

- Input(LNK_12_bwire_T1) (lumped port 1)
- Output(TXCLK_12_bwire_T1) (lumped port 5)
- Output(TXCLK_12_sball_T1) (lumped port 6)

Create the plot as follows:

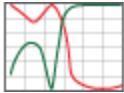
1. On the **Results** ribbon tab, click  **Terminal Solution Data Report** >  **2D**.
2. In the *Report* dialog box that appears, specify the following settings:
 - a. Ensure that **Setup1 : Transient** is selected from the **Solution** drop-down menu and **Time** from the **Primary Sweep** drop-down menu.

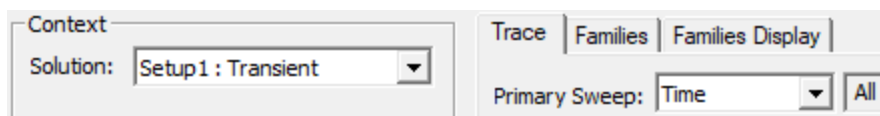

Figure 4-1: Solution and Primary Sweep Settings (Transient)

- b. Select **Transient** in the **Category** list.
- c. Select the following three items in the **Quantity** list:
 - **Input(LNK_12bwire_T1)**
 - **Output(TXCLK_12bwire_T1,LNK_12_bwire_T1)**
 - **Output(TXCLK_12sball_T1,LNK_12_bwire_T1)**
- d. Select **<none>** in the **Function** list.

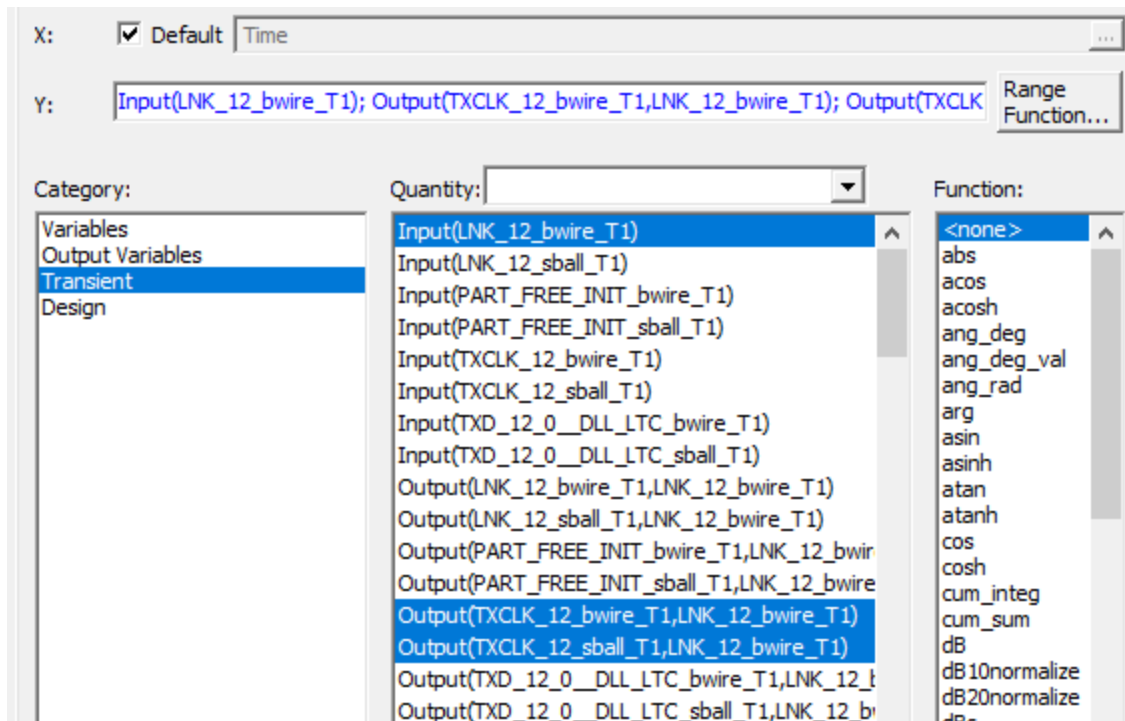

Figure 4-2: Transient Plot 1 Trace Settings

3. Click **New Report** but leave the dialog box open for creating the next plot.

Transient Plot 1 appears in a new window. (Move the *Report* dialog box to the side or move the plot window for an unobstructed view.)

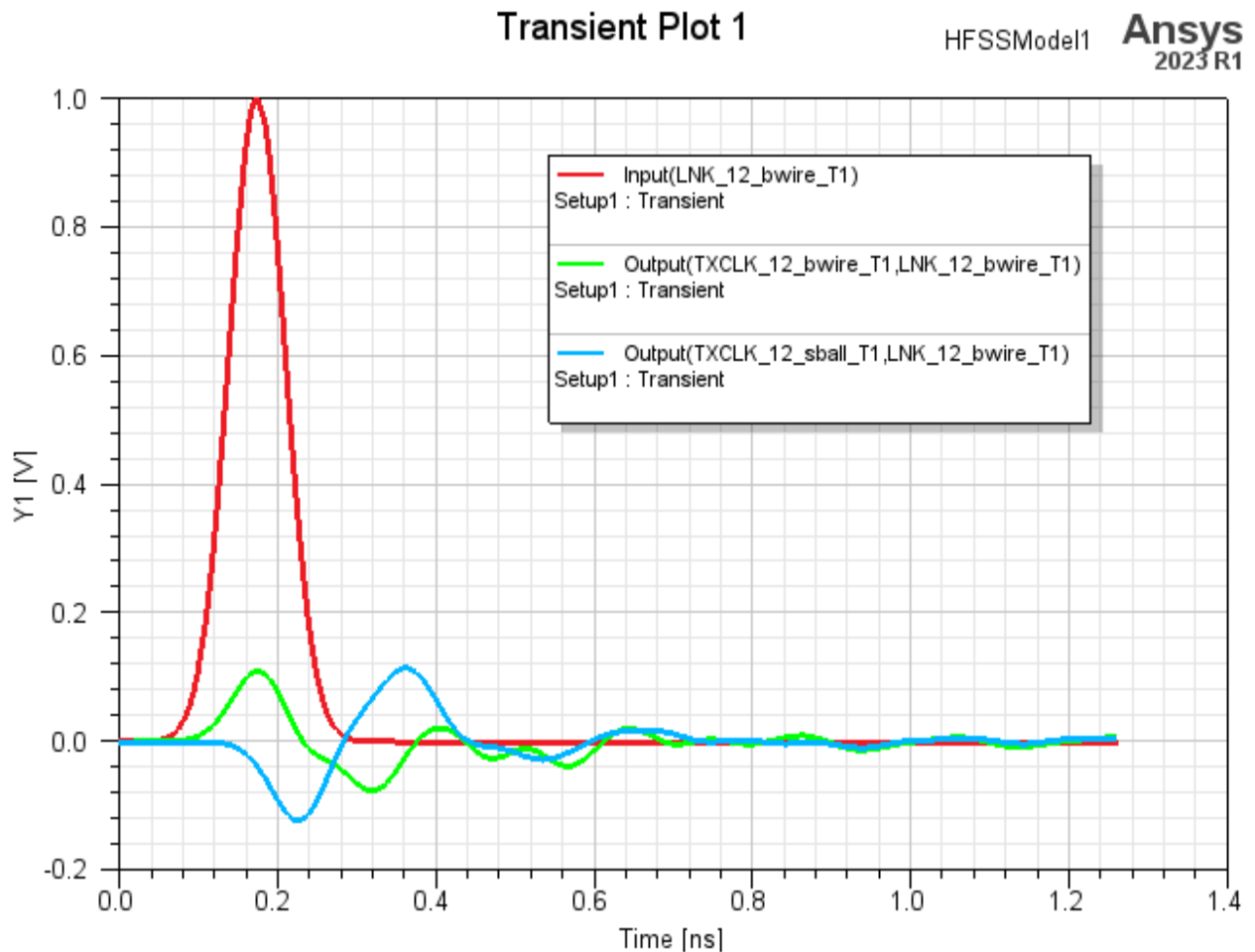

Figure 4-3: Input Pulse and Response vs. Time

Residual

The Residual is a measure of the maximum field remaining anywhere in the model. It is used as a stopping criterion under the *Duration* tab of the *Transient Solution Setup* dialog box. By default, when the peak field has fallen to 0.001 times its maximum, the simulation is considered complete. An example of a Residual plot with a logarithmic vertical scale is shown below. Monitoring a plot like this during the simulation gives an idea of how much longer the simulation might take. The progress bar gives complementary information; it is based on the maximum simulated time. The residual doesn't go down to -60 dB since the specified settings stopped the simulation early.

You will plot the residual quantity at lumped port 6 using the dB20 function (20 times the base 10 logarithm of the quantity).

The *Report* dialog box should still be open from the previous plot creation. If not, repeat [step 1 of the previous topic](#) before proceeding to the steps below.

1. Keeping the *Solution* setting as it is (*Setup1 : Transient*), specify the **Trace** tab settings for the Residual plot as shown in the following figure:

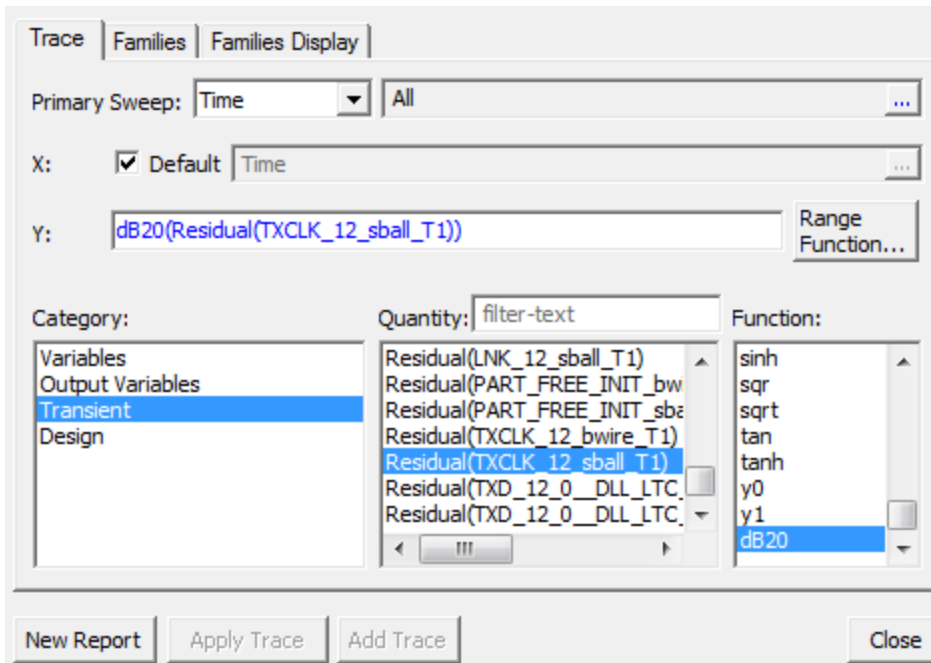

Figure 4-4: Residual Plot Settings

2. Click **New Report** and then click **Close**.

HFSS generates the Residual plot:

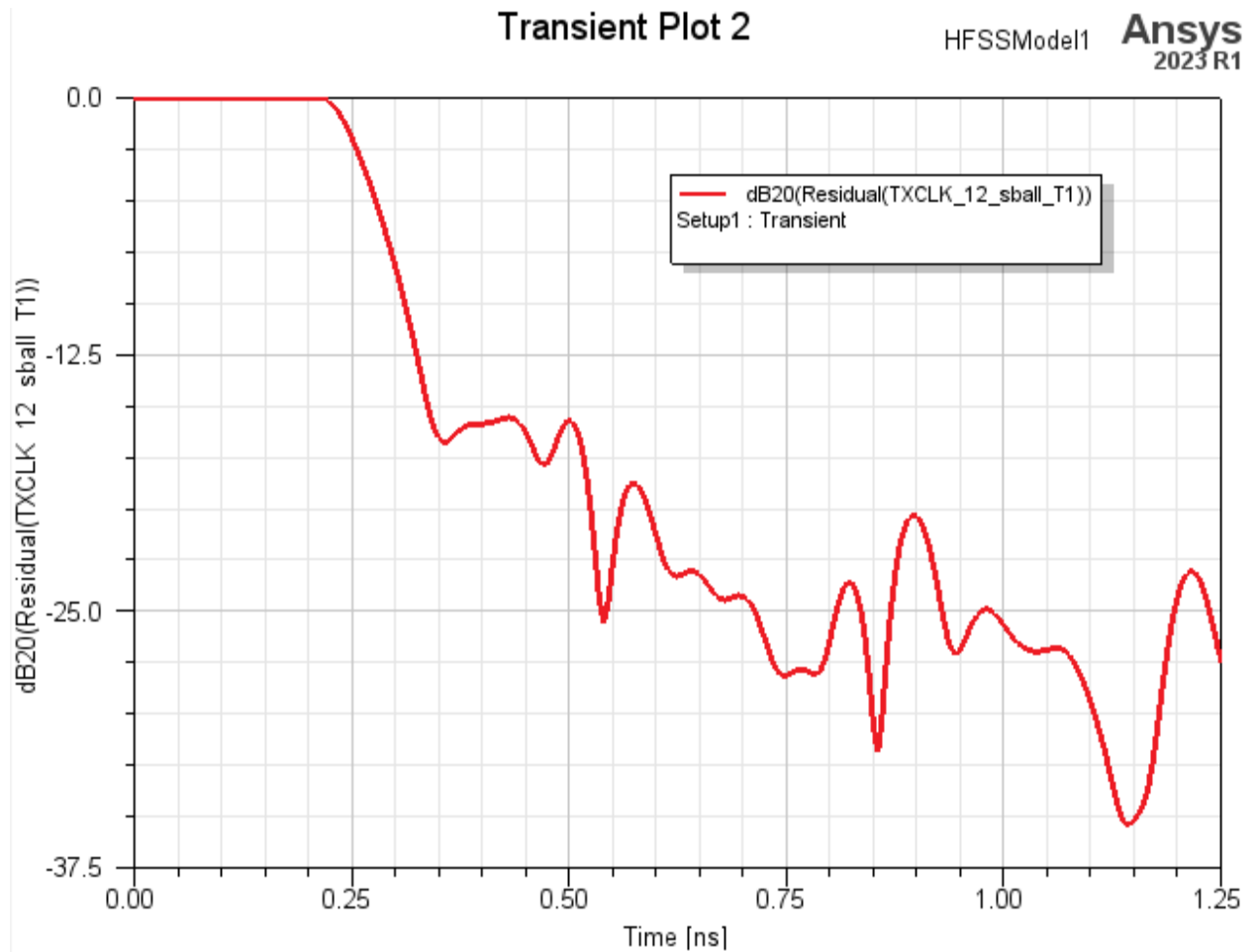

Figure 4-5: Residual Plot

E-Fields Overlay

To overlay the transient E-fields on the previously designated faces of the model, do the following:

1. Return to the Modeler window. (You can click in the window's title bar if it is visible or bring it back to the foreground using the **Window** menu.)
2. Under *Lists* in the Modeler Tree, select **PlotFields**.

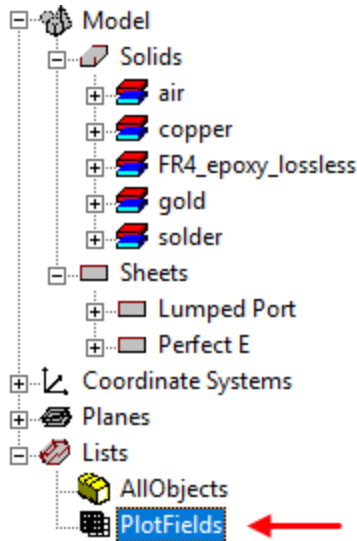

Figure 4-6: Selecting the *PlotFields* Face List

3. In the Project Manager, right-click **Field Overlays** and choose **Plot Fields > E_t > Mag E_t** from the shortcut menu.

The *Create Field Plot* dialog box appears.

4. Under *Intrinsic Variables*, select a **Time** from the drop-down menu (for example, **500ps**). Keep the other settings at their defaults.

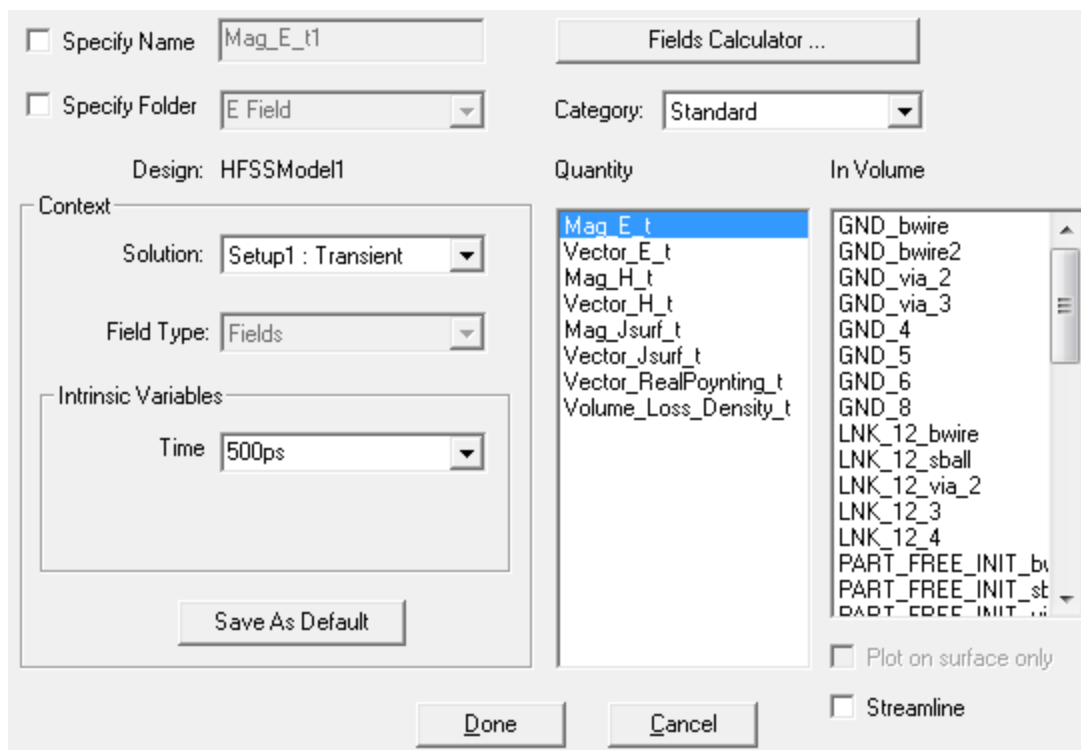



Figure 4-7: Field Plot Settings

5. Click **Done**.
The field overlay and legend appear in the Modeler window.
6. On the **Draw** ribbon tab, click  **Grid** to toggle off the grid visibility.
7. As desired, **middle-click** and drag the mouse to **rotate** the viewpoint, **Ctrl + middle-click** and drag to **pan**, and/or **roll the mouse wheel** to **zoom** in or out for a good model viewpoint.

The field overlay should resemble the following figure:

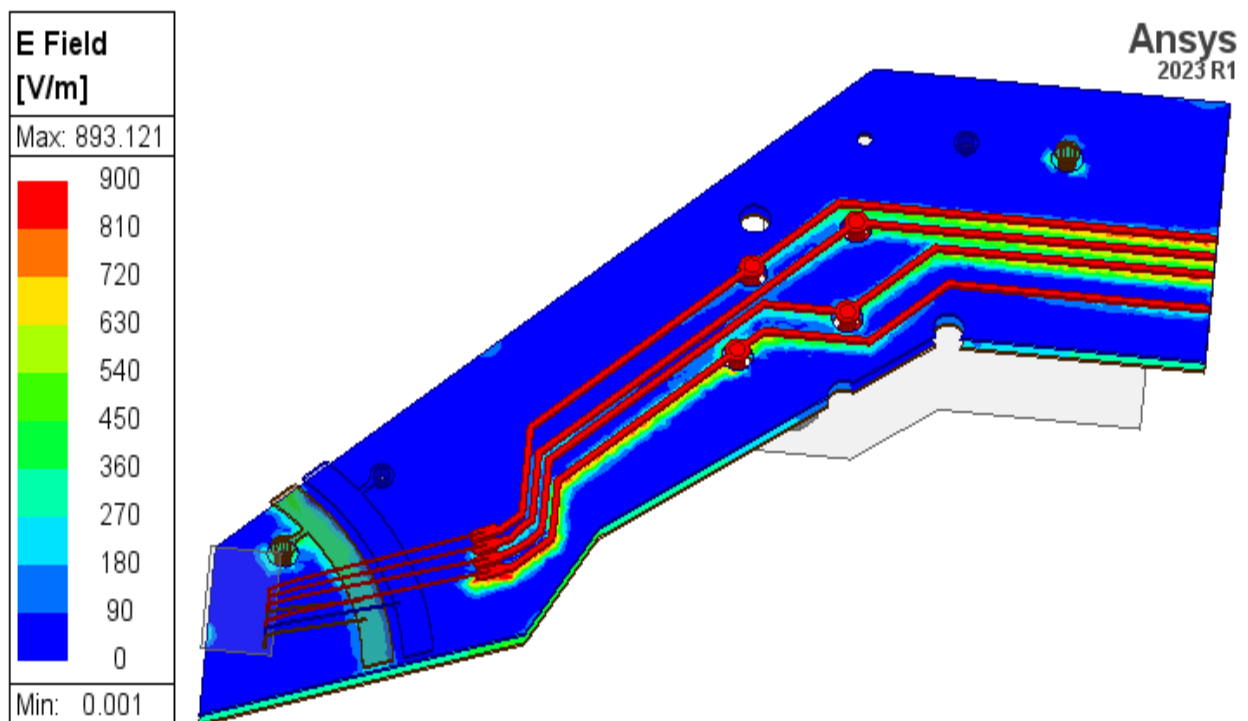

Figure 4-8: E-Field Overlay – Power Plane View (Time = 500ps)

8. **Rotate**, **zoom**, and **pan** the model again, this time for a good view of the *bottom* face.
9. Double-click within the **E Field legend** to access plot color and scaling options.
10. On the **Scale** tab, make the following changes:
 - a. Select the **Use Limits** option.
 - b. In the **Max** text box, type **400**.
11. On the **Plots** tab, select **Gourard** from the **IsoValType** drop-down menu.
12. Click **Close**.

The plot should now resemble the following figure:

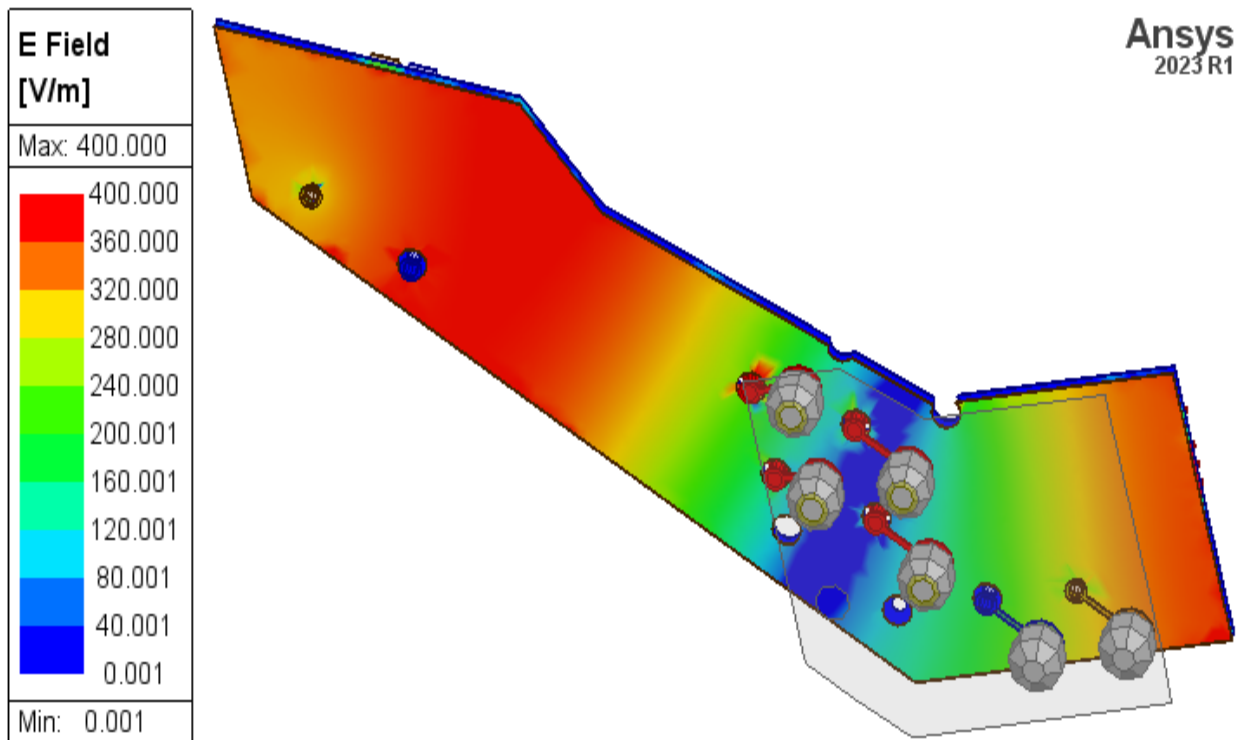

Figure 4-9: E-Field Overlay – Ground Plane View (Time = 500ps)

13. Under *Field Overlays* > *E Field* in the Project Manager, right-click **Mag_E_t1** and choose **Animate**.
14. Specify the following settings in the *Create Animation Setup* dialog box that appears:
 - a. In the **Description** text box, type **Late-Time Plane Resonances**.
 - b. In the **Start** text box, type **560ps**.
 - c. In the **Steps** text box, type **80**. (This setting will produce animation frames withing the specified time range at every other time step that was calculated.)

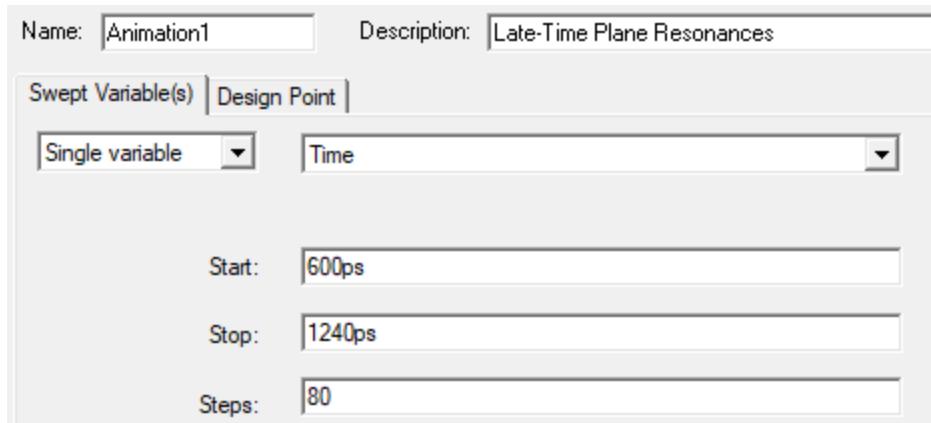

Figure 4-10: Field Animation Setup

15. Click **OK**.

There will be a delay while the animation frames are computed, and then the *Animation* dialog box will appear and the overlay animation will start playing.

16. Use the available animation controls to pause, restart, reverse, or change the speed of the animation.

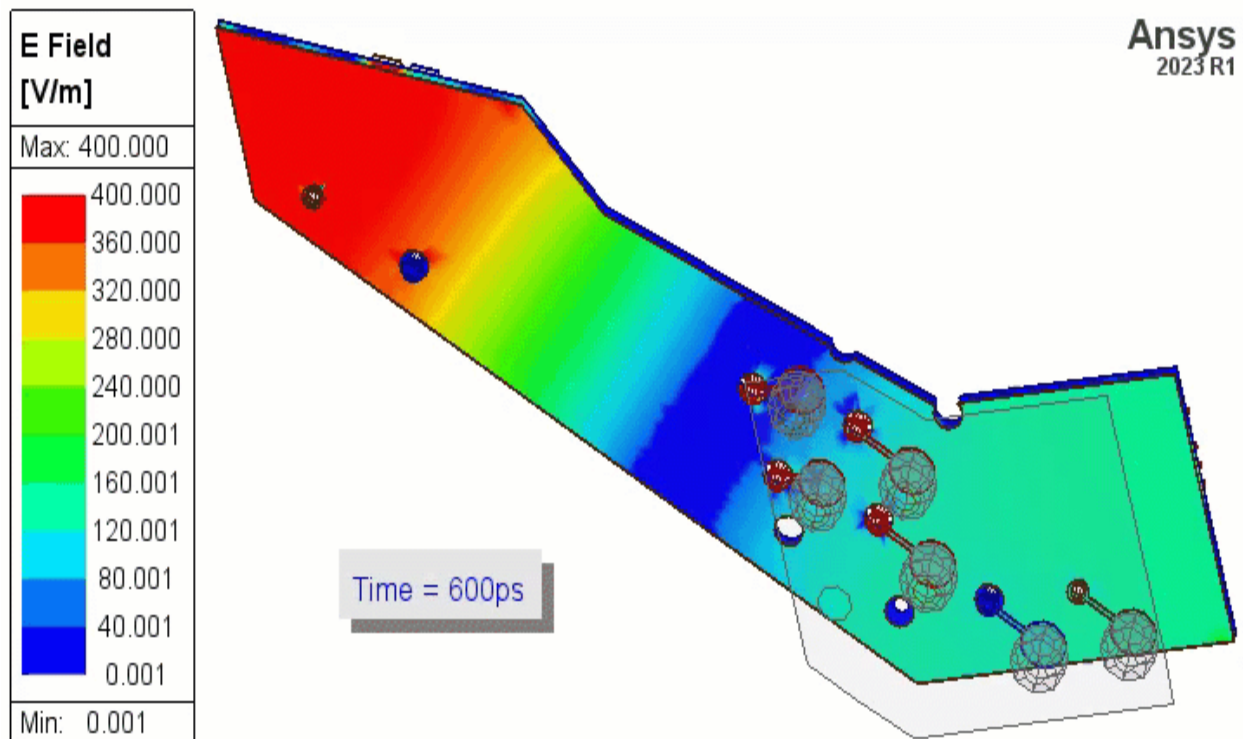

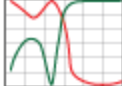

Figure 4-11: E-Field Animation

17. In the *Animation* dialog box, click **Close** when you're done viewing the animation.

S-Parameters vs. Frequency

1. On the **Results** ribbon tab, click  **Terminal Solution Data Report** >  **2D**.
The *Report* dialog box appears.
2. In the *Context* area, choose **Setup1 : Spectral** from the **Solution** drop-down menu.

This change enables you to plot frequency-domain S-parameters generated by the transient simulation. Notice that the *Primary Sweep* setting has changed from *Time* to *Freq*.

Note:

Even while a simulation is still running, the transient solver can give you frequency-domain S-parameters based on the transient information it has gathered thus far. The plot will be updated frequently. This process can slow down the overall simulation, since every update requires transformations from time domain to frequency domain. Of course, at this point, the Ball Grid Array simulation has already been completed.

3. Make the **Category**, **Quantity**, and **Function** selections shown in the following figure:

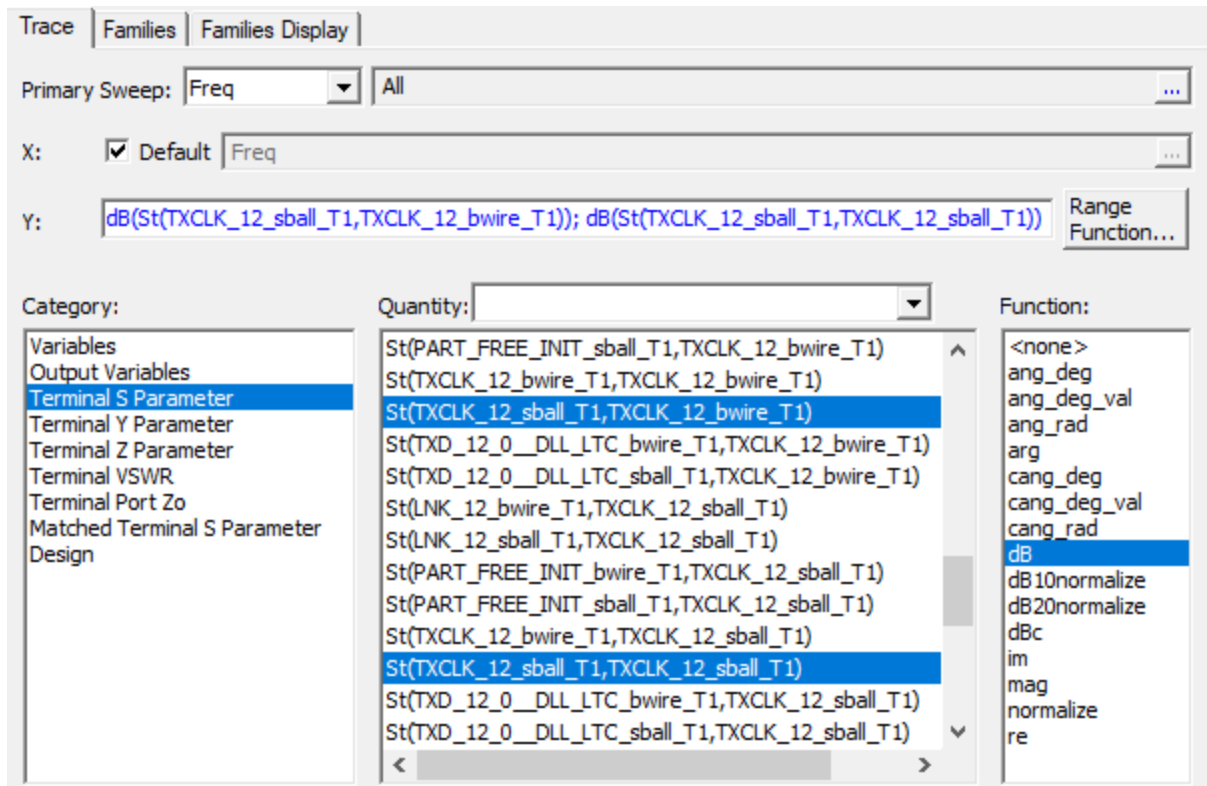

Figure 4-12: S-Parameter Plot Settings

Note:

These two S-parameters are an example of the transmission and reflection for a particular signal line (specifically, *TXCLK_12*). If represented according to the associated lumped port numbers, the S-parameter designations would be S(6,5) and S(6,6), which are the transmission and reflection results, respectively.

4. Click **New Report** and then **Close**.

Terminal S-Parameter Plot 1 appears in a new window:

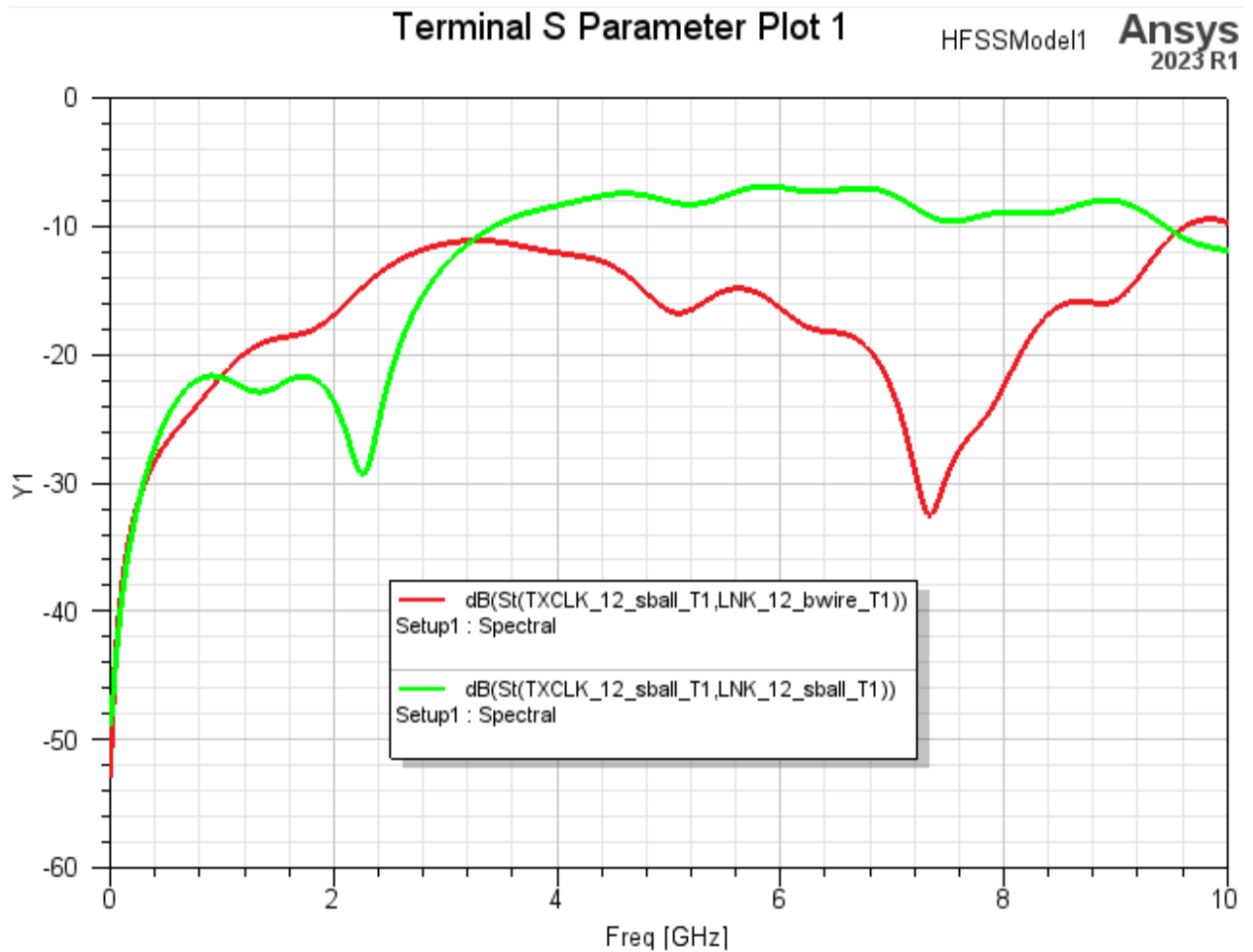



Figure 4-13: S-Parameters vs. Frequency Plot

Observations:

- The transmission for the TXCLK_12 signal line (red curve) is approximately 0 dB for DC conditions and tends to decrease with frequency until a sharp decrease and minimal transmission result occurs at about 8.7 GHz. Beyond this frequency, the transmission increases again.
- The reflection for the TXCLK_12 signal line (green curve) is minimal at DC conditions and tends to increase with frequency, though there is another dip in reflection at about 2.3 GHz. Beyond about 3.6 GHz the reflection curve flattens out and then declines slightly beyond 9 GHz.

5.  **Save your project.**

You have completed the Ball Grid Array IC Package exercise. You can now save and close the project.